



Extremely Important Harness System Information

Most or all of our seat belts meet or exceed SFI-16 specifications. Useful life of webbing in the best conditions should not exceed two years and it is highly recommended that it be replaced at or before that time. If involved in an accident or fire, or if webbing shows wear or abuse, then it should be replaced or returned to the manufacturer for inspection. All metal hardware should not be welded on, bent or straightened or modified in any way. Seat belts should not be exposed to excessive heat, gasoline, solvents, or anything that could degrade or damage them. It is very important that the user should inspect seat belts before each and every use. Seat belts are manufactured for off-road use only. Seat belts should always be used as a complete set (lap belt, shoulder harness and crotch strap).

Important Notice

Seat belt webbing is designed to stretch up to 20% of its total length to help absorb impact. Your body also stretches in an impact. Be sure to have adequate clearance for the driver from the steering wheel, rollbars and other impact areas in the vehicle. Pad those areas where the driver may experience unavoidable contact as a result of an accident. (WARNING: Seat belts are not D.O.T. approved and should not be used for street use).

Warning

Motor racing is extremely dangerous. Death or injury will occur. The products we sell have no warranty or representations made with the ability to protect against injury or death. The user assumes that risk. Most or all of the items are for off road use only and are not approved or recommended for street use.

Installation Instructions

Harness sets are designed for use with a sub-strap. Use of harness set without sub-strap can cause serious injuries!

The sub-strap holds the harness buckle in place over the pelvis area and helps prevent the driver from sliding down in the seat.

The pelvis area can withstand 5000lbs. of load before serious injury where the abdominal area can withstand only 800 lbs. of load so it is very important that the harness remains in the proper location.

Seat belt installation instructions are general guidelines only. Please refer to the installation requirements of the sanctioning body you are racing under or consult a professional engineer for your particular application.

Floor mount hardware on the ends of the lap belt that attaches your belt assembly to the floor must be mounted in a vertical position. When using this type of hardware for any reason, shoulder harnesses or belts must be mounted vertically. Seat belts are not to be mounted to sheetmetal, but to frame, rollcage or factory seatbelt mounting points.

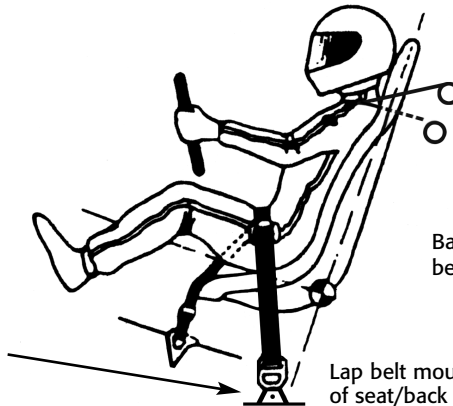

Shoulder harness should not be anchored more than 1"-4" below shoulder height.

Mounting below this height may cause additional spinal compression.

Back of an aluminum seat should be braced for support.

VERTICAL

Lap belt mounting point is 2.5" forward of seat/back intersection.

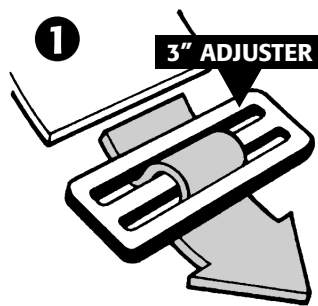

1 Lace webbing through adjuster for lap and shoulder belts.

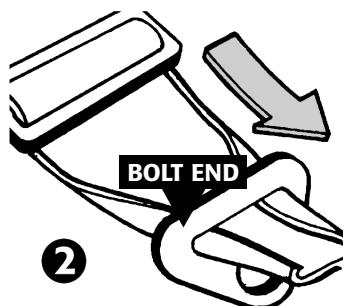

2 Fold both edges of webbing to center in order to pass through bolt end.

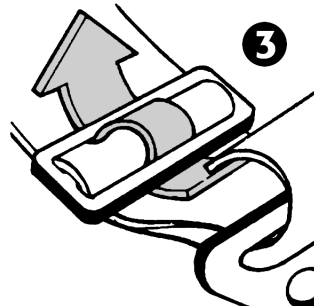

3 Slide webbing through or around hardware.

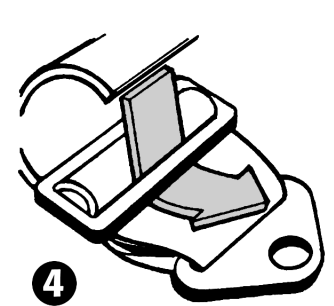

4 Lace webbing back through adjuster to lock webbing in place.

See Reverse Side for important SFI information.

The primary goal of any race car driver is to be the best and cross the finish line first. This is achieved by putting long hours of hard work into the engine and tweaking the chassis just right. A lot of thought goes into shaving every fraction of a second off lap time in order to gain even the slightest advantage over competitors.

Hopefully just as much thought goes into driver safety equipment as into the engine. Using quality safety equipment can help a driver get to the finish line in one piece as well as first.

An integral part of safety equipment is the driver restraint assembly, or seat belts, to keep the driver inside the roll cage where the least amount of injury will occur in a crash.

The Anatomy of a Seat Belt

A restraint assembly consists of several components, each with a specific function. The shoulder harness is a belt assembly, one strap for each shoulder, intended to restrain movement of the upper torso and shoulder regions. An optional cross strap across the chest can be used to hold the shoulder harness together. The lap belt restrains movement of the pelvis and the anti-submarine strap prevents the pelvis from slipping forward from under the lap belt in the event of an accident.

The buckle which attaches the belts together should have a quick and easy release mechanism in the case of an emergency situation. There are three types of buckles to choose from: latch/lever, turn/push, and cam lock. All three can be opened in 1 or 2 motions.

A restraint assembly also utilizes two types of hardware. The adjustment hardware is used to alter the length of the individual straps to fit the driver. Mounting hardware secures each strap to the vehicle.

SFI Helps Maintain Quality Assurance in Seat Belt Performance

The purchase of belts should be based on more important criteria than whether or not the color matches the car. One way to tell if one manufacturer's restraint assembly is more reliable than another's is to look for belts that are certified to meet performance specifications. Manufacturers whose products pass the standard laboratory tests participate in the SFI Foundation, Inc.'s certification program.

What is SFI Foundation, Inc. and what do they do? SFI is a non-profit organization established to issue and administer standards for all kinds of specialty/performance automotive and racing equipment. Manufacturers of equipment are the primary users of SFI standards.

Some standards are adopted as part of the rules of race sanctioning bodies. Ultimately, the consumer benefits from the program because it establishes recognized levels of performance or quality for a product such as driver restraint assemblies.

The specifications are created through a committee process. Technical committees are comprised of individuals from all facets of the industry who provide a comprehensive cross-section of knowledge. Such diverse expertise and open participation is the means by which standards are fairly established.

Participation in the program is purely voluntary, so this does not mean that all manufacturers not in the program produce inferior belts. Their restraint assemblies may be just as good as one that is certified, but they merely choose not to participate in the SFI program. However, to ensure quality belts, it would be a good idea to look for the SFI label.

The standard that applies to safety belts is SFI Specification 16.1. The spec defines a driver restraint assembly and outlines basic design dimensions and requirements. It also explains the testing procedures in detail and how to interpret the test results to determine if the product meets the required criteria and thus passes the test.

Once a product is passed, the manufacturer installs SFI certification tags on the belts which display the date of manufacture. The purpose of the dated certification tags is to enable drivers and race officials to easily determine when the belts reach their 2-year life span. One of the most important requirements of the specification states that the useful life of the webbing in the straps of the restraint assembly shall not exceed two years and they must be replaced at or before that time. Only the original manufacturer can reweb an assembly prior to recertifying.

Seat Belts Should be Inspected and Recertified Every Two Years
Restraints must be maintained, inspected, and replaced or rewebbed

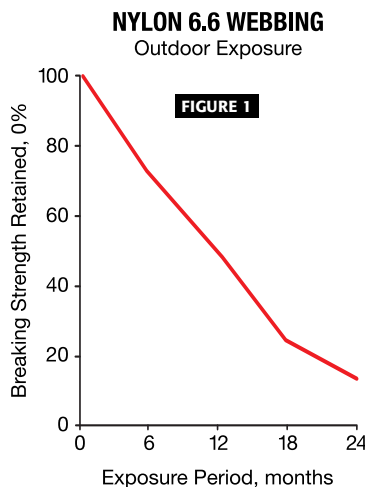

every two years because they degenerate from exposure to the elements and over time. Prolonged exposure of seat belt webbing and thread to sunlight can cause degradation of the fibers and loss of restraint integrity.

The rate at which the breaking strength of the webbing decreases with outdoor exposure is illustrated in Figure 1. The webbing used in motorsports restraints is typically made with DuPont Nylon 6-6 or a similar product. According to the data, the webbing loses about half of its strength in one year.

With this kind of rapid deterioration, it is obvious why replacing the webbing every two years is essential to driver safety. Old and weakened belts could easily snap under the loads imposed upon them in an accident situation. Failure to properly restrain the driver in a crash would have devastating consequences.

Proper Installation is Important

The effectiveness of a restraint assembly is also influenced by attachment techniques. The principal precaution for installing the mounting hardware to the vehicle is to minimize bending stress in the fitting. This is achieved by making sure the belts pull from a straight angle against the hardware. The assembly should be installed so that the straps do not rub against any surface that can cause the webbing to fray. The anchoring mechanisms should also be periodically checked so that they don't become loose or weakened.

Proper installation of the restraint assembly also means achieving the correct fit to the driver. Belts should be as short as possible to reduce stretching for better control of occupant movement.

The attachment points must provide the optimum geometry to minimize movement of the belts. Lap belts perform best when they act at an angle between 45° and 55° relative to the longitudinal axis of the vehicle as illustrated in part A of Figure 2. This angle permits the lap belt to react to the upward pull of the shoulder harness. A system installed with a shallow belt angle, as shown in part B of Figure 2, permits the shoulder harness to pull the lap belt up off the pelvic area and into the abdominal region with the likelihood of injury to internal organs.

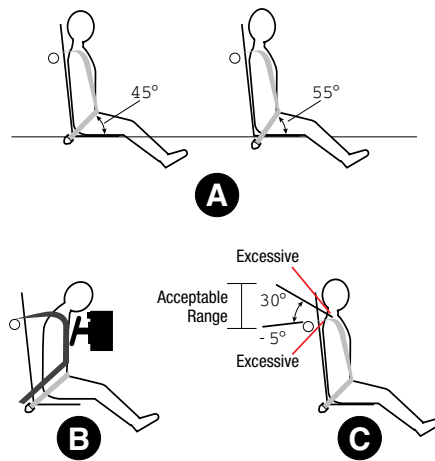

FIGURE 2

The end attachments of the shoulder harness must also be installed at appropriate angles. The ideal position is anywhere between 5° below and 30° above the driver's shoulder, as seen in part C of Figure 2.

If the upper attachment point falls significantly below the driver's shoulder, then a spinal compression injury is likely to occur. In an accident situation, the shoulder belts pull down and back on the torso as they resist the forward motion of the driver. The resultant restraint force compresses the spinal column and will add to the stresses in the spine already caused by the force of the crash impact.

On the other hand, if the trailing ends of the harness are too far above the shoulder (greater than 30°), then two problems can occur. First, tension in the shoulder harness is increased and undue stress is applied to the harness and its structural attachments. Second, excessive angle will cause excessive motion. If the harness belts are too far above the shoulder, they will provide little resistance to forward motion of the driver's upper torso. The result is impact with the steering wheel and the possibility of neck injury. The shoulder straps should also be 3-6" apart behind the driver's neck to prevent slippage off the shoulders.

The reliability of a restraint system is greatly affected by the way it is installed. It is imperative to follow the installation instructions provided by the seat belt manufacturer. Also, the necessity of replacing or rewebbing seat belts every two years cannot be more important.

As cars become more advanced and consequently go faster, everything possible must be done to make the racing experience safe as well as fun. Failure to do so can cause serious injury, or worse. If there is anything that can be learned from the sport of racing, it's that anything is possible, and taking the attitude that "it won't happen to me" is risky, because it does happen.

Reprinted from SFI Foundation/Jennifer M. Bowden